

K-No.: 26656

50A Current Sensor

For the electronic measurement of currents:
DC, AC, pulsed, mixed with a galvanic Isolation
between the primary circuit (high power) and the
secondary circuit (electronic circuit)



Date: 28.10.2024

Customer: Standard type

Customers Part no:

Page 1 of 4

Description

- Closed loop (compensation)
Current Sensor with magnetic probe
- Printed circuit board mounting
- Casing and materials UL-listed

Characteristics

- excellent accuracy
- very low offset current
- very low temperature dependency and offset current drift
- very low hysteresis of offset current
- short response time
- wide frequency bandwidth
- compact design
- reduced offset ripple

Applications

Mainly used for stationary operation in industrial applications:

- Solar inverter

Electrical data - Ratings

I_{PN}	Primary nominal RMS current	50	A
V_{OUT}	Output voltage @ I_P	$V_{REF} \pm (0.625 \cdot I_P / I_{PN})$	V
V_{OUT}	Output voltage @ $I_P=0A, \theta_A=25^\circ C$	$V_{REF} \pm 0.0025$	V
V_{REF}	External Reference voltage range	0 ... 4	V
	Internal Reference voltage	2.5 ± 0.005	V
K_N	Transformation ratio	(1) : 1000	

Accuracy – Dynamic performance data

		min.	typ.	max.	Unit
$I_{P,max}$	Max. measuring range	± 172			A
X	Accuracy @ $I_{PN}, \theta_A = 25^\circ C$			1	%
ϵ_L	Linearity			0.1	%
$V_{OUT}-V_{REF}$	Offset voltage @ $I_P = 0A, \theta_A = 25^\circ C$			2.5	mV
$\Delta V_O / V_{REF} / \Delta T$	Temperature drift of V_{OUT} @ $I_P=0A, V_{REF}=2.5V, \vartheta_A$		4	10	ppm/ $^\circ C$
t_r	Response time		1		μs
t_{ra}	Reaction time		1		μs
f_{BW}	Frequency bandwidth	DC..100			kHz

General data

ϑ_A	Ambient operation temperature	-40		85	$^\circ C$
ϑ_S	Ambient storage temperature (acc. to M3101)	-40		85	$^\circ C$
m	Mass		18		g
V_C	Supply voltage	4.75	5	5.25	V
I_C	Supply current at $I_P = 0A$ and RT		16		mA

$^1)S_{clear}$	Clearance (component without solder pad)	12			mm
$^1)S_{creep}$	Creepage (component without solder pad)	12			mm
$^1)U_{sys}$	System voltage *determines impulse voltage acc. table 7			600	V_{RMS}
$^1)U_{AC}$	Working voltage *acc. table 10			1000	V_{RMS}
$^1)U_{PD}$	Rated discharge voltage *acc. table 24 with $U_{PD} = U_{AC} \cdot \sqrt{2}$ max. Potential Difference acc. to UL 508			1414	V_{PEAK}
				600	V_{RMS}

1) Constructed and manufactured and tested in accordance with IEC 61800-5-1:2007 (primary to secondary)
Reinforced insulation, Insulation material group 1, Pollution degree 2, Overvoltage category III

The current sensor passed the EMI susceptibility tests (vertical and horizontal, one direction) according to the standard 61000-4-3:2010 at 20V/m, 80%AM@1kHz over the frequency range of 80MHz to 1000MHz, level a) with <2% variation of the V_{out} during the stress.

Date	Name	Issue	Amendment
28.10.2024	DJ	81	Missing measure added on p.2. CN-24-095

Hrg.: R&D-PD CS editor	Bearb.: DJ designer	MC-PM: FS check	freig.: SB released
------------------------	---------------------	-----------------	---------------------

K-No.: 26656

50A Current Sensor

For the electronic measurement of currents:
DC, AC, pulsed, mixed with a galvanic Isolation
between the primary circuit (high power) and the
secondary circuit (electronic circuit)



Date: 28.10.2024

Customer: Standard type

Customers Part no:

Page 2 of 4

Mechanical outline (mm):

General tolerances DIN ISO 2768-c

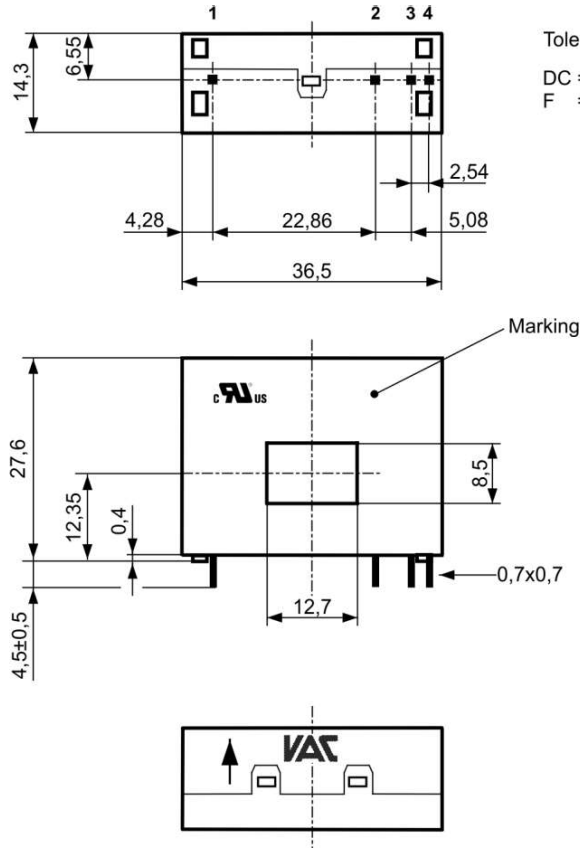

Tolerance of Pin distance ±0,2mm

DC = Date Code
F = Factory

Connections:

Pin Nr. 1-4: 0.7 x 0.7mm

Marking:
UL-sign
4647-X161
F DC

Schematic diagram:

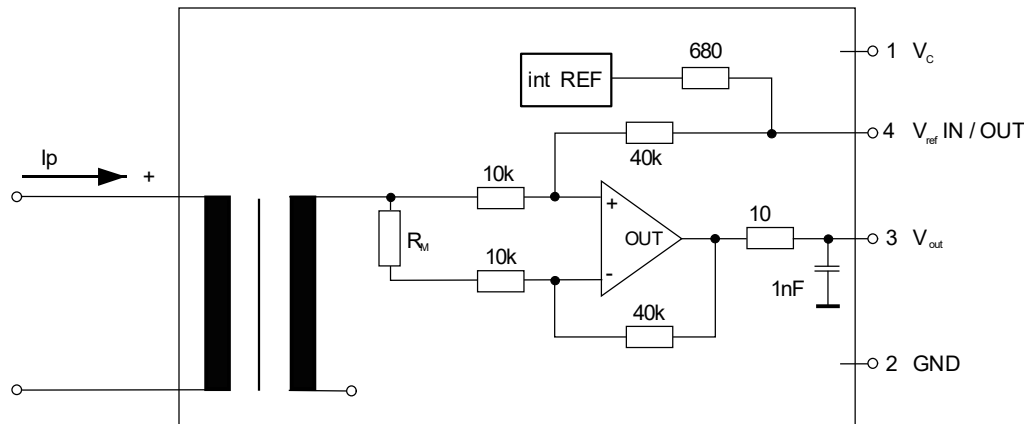

Hrg.: R&D-PD CS
editor

Bearb.: DJ
designer

MC-PM: FS
check

freig.: SB
released

K-No.: 26656

50A Current Sensor

For the electronic measurement of currents:
DC, AC, pulsed, mixed with a galvanic Isolation
between the primary circuit (high power) and the
secondary circuit (electronic circuit)



Date: 28.10.2024

Customer: Standard type

Customers Part no:

Page 3 of 4

Electrical data: (investigate by a type checking)

		min.	typ.	max.	Unit
$V_{C,tot}$	maximum supply voltage (without function)			7	V
I_C	Supply Current with primary current	$16mA + I_P \cdot K_N + V_{OUT}/R_L$			mA
$I_{OUT,SC}$	Short circuit output current		± 20		mA
R_S	Secondary coil resistance @ $\theta_A = 85^\circ C$			14	Ω
$R_{I,REF}$	Internal resistance of Reference output		680		Ω
$R_{I,Vout}$	Output resistance of V_{OUT}		10		Ω
R_L	External recommended resistance of V_{OUT}	1			k Ω
C_L	External recommended capacitance of V_{OUT}			1	nF
$X_\theta / \Delta\theta$	Temperature drift of X @ $\theta_A = -40^\circ C \dots 85^\circ C$			40	ppm/K
$\Delta V_O = \Delta(V_{OUT} - V_{REF})$	Sum of any offset drift including:		2	6	mV
V_{Ot}	Long term drift of V_O		1		mV
V_{OT}	Temperature drift of V_O @ $\theta_A = -40^\circ C \dots 85^\circ C$		1		mV
V_{OH}	Hysteresis of V_{OUT} @ $I_P = 0A$ (caused by $I_P = 10 \times I_{PN}$)			1.5	mV
$\Delta V_O / \Delta V_C$	Supply voltage rejection ratio			1	mV/V
V_{OSS}	Offsetripple (with 1 MHz-Filter, first order)			22	mV _{PP}
V_{OSS}	Offsetripple (with 100 kHz-Filter, first order)		5	8	mV _{PP}
V_{OSS}	Offsetripple (with 20 kHz-Filter, first order)		2	5	mV _{PP}
C_k	Maximum possible coupling capacity (primary - secondary)		6		pF
	Mechanical stress according to M3209/3 Settings: 10-2000Hz, 1min/oct., 2 hours		tbd		g

Routine Tests: (Measurement after temperature balance of the samples at room temperature, SC=significant characteristic)

V_{OUT} (SC)	(100%) M3011/6:	Output voltage	$625 \pm 1\%$	mV
V_O	(100%) M3226:	Offset voltage	± 2.5	mV
U_d	(100%) M3014:	Test voltage, 1s	1.8	kV _{RMS}
U_{PDE}	(AQL 1/S4)	Partial discharge voltage (extinction)	1.5	kV _{RMS}
$U_{PD} \cdot 1.875$	M3024		1.875	

Type testing: (Precondition acc. to M3236)

\hat{U}_W	M3064	HV transient test 1,2 μ s / 50 μ s-Waveform	8	kV
U_d	M3014	Test voltage (5s)	3.6	kV _{RMS}
U_{PDE}	M3024	Partial discharge voltage (extinction)	1.5	kV _{RMS}
$U_{PD} \cdot 1.875$			1.875	

Other instructions:

- Current direction: A positive output voltage vs. V_{REF} appears at point V_{OUT} , if primary current flows in direction of the arrow.
- Constructed, manufactured and tested in accordance with IEC 61800-5-1:2007.
- Temperature of the primary conductor should not exceed 105°C.
- Housing and bobbin material UL-listed: Flammability class 94V-0.
- Further standards: UL 508, file E317483, category NMTR2 / NMTR8

Hrg.: R&D-PD CS
editor

Bearb.: DJ
designer

MC-PM: FS
check

freig.: SB
released

K-No.: 26656

50A Current Sensor

For the electronic measurement of currents:
DC, AC, pulsed, mixed with a galvanic Isolation
between the primary circuit (high power) and the
secondary circuit (electronic circuit)



Date: 28.10.2024

Customer: Standard type

Customers Part no:

Page 4 of 4

Explanation of several terms used in the tables:

V_{0t} Long term drift of V_O after 100 temperature cycles in the range -40°C to 85°C .

t_r Response time, measured as a delay time at $I_P = 0.9 * I_{PN}$ between a rectangular primary current and the output current or voltage.

t_{ra} Reaction time, measured as a delay time at $I_P = 0.1 * I_{PN}$ between a rectangular primary current and the output current or voltage.

$X_{ges}(I_{PN})$ The sum of all possible errors over the temperature range by measuring a current I_{PN} :

$$X_{ges}(I_{PN}) = 100 * \left| \frac{V_{OUT}(I_{PN}) - 2.5V}{0.625V} - 1 \right| \%$$

X Permissible measurement error in the final inspection at RT, defined by

$$X = 100 * \left| \frac{V_{OUT}(I_{PN}) - V_{OUT}(0)}{0.625V} - 1 \right| \%$$

ΔX_{θ} $\Delta X_{\theta} = X_{\theta_{max}} - X_{\theta_{min}}$

ϵ_L Linearity fault defined by: $\epsilon_L = 100 * \left| \frac{I_P}{I_{PN}} - \frac{V_{OUT}(I_P) - V_{OUT}(0)}{V_{OUT}(I_{PN}) - V_{OUT}(0)} \right| \%$

Where I_P is any input DC current and V_{OUT} the corresponding output term. ($V_O = 0$).

RT Room temperature

