

**Differential Current Sensor for EV-charging acc. to the partly combined standards IEC62955-1:2018 and UL2231-2 Ed.2**



Date: 03.12.2024

K-No.:30626

Customer: Standard type

Page 1 of 12

### Description

- Fluxgate current sensor with toroidal core
- PCB mounting

### Characteristics

- Excellent accuracy
- Switching open-collector outputs
- Compact design

### Applications

- Mainly used for stationary and mobile applications:
- Wallbox
  - Personnel Protection Systems for EV acc. to UL2231

Patents: EP2571128 / US9397494 / CN103001175 // EP2813856

### Electrical data – Ratings

		min.	typ.	max.	Unit
$I_P$	Primary nominal RMS current (1phase / 3phase)			80 / 40	A
$I_{\Delta N1}$	Rated residual operating current 1		6		mA dc
$I_{\Delta N2}$	Rated residual operating current 2		20		mA rms
$I_{\Delta N1, tolerance}$	Trip tolerance 1	4	5	6	mA dc
$I_{\Delta N2, tolerance}$	Trip tolerance 2	15		20 <sup>(1)</sup> / 70 <sup>(2)</sup>	mA rms
$I_{\Delta RI,1}$ (Fig.3)	Recovery Current level for $I_{\Delta N1}$ (absolute value DC)		2.5		mA
$I_{\Delta RI,2}$ (Fig.3)	Recovery Current level for $I_{\Delta N2}$ (absolute value rms)		10		mA

(1) f = 50/60 Hz (2) f = DC to 2kHz

### Accuracy – Dynamic performance data

$I_{\Delta N,max}$	Max. measuring range (peak)	-300		+300	mA
X	Resolution (@ $I_{\Delta N}$ , $\Theta_A = 25^\circ C$ )		< 0.2		mA
$t_r$	Response time <sup>(3)</sup>			see Fig.2	
$f_{BW}$ (Fig.5)	Frequency range	DC		2	kHz

### General data

$\vartheta_A$	Ambient operation temperature	-40		85	°C
$\vartheta_{Storage}$	Ambient storage temperature	-40		85	°C
m	Mass		21		g
$V_{CC}$	Supply voltage	4.8	5	5.2	V <sub>DC</sub>
$I_{CC}$	Supply current		33		mA rms
$S_{clear, pp}$	Clearance (primary to secondary) <sup>(4)</sup>			8mm	
$S_{creep, pp}$	Creepage (primary to secondary) <sup>(4)</sup>			8mm	
FIT	EN/IEC 61709 / SN 29500 <sup>(5)</sup>			< 2200	fit

<sup>(3)</sup> Switching time of a relay (IEC: t = 20ms / UL: t = 10ms) is considered.

<sup>(4)</sup> Constructed, manufactured and tested in accordance with IEC60664-1:2020

Isolated wires are preferred to fulfill the insulation coordination acc. to IEC 62955:2018, it is necessary to use insulated primary conductors that meet the requirements of the basic insulation for the rated voltage. If isolated primary conductors are used, the isolation coordination is acc. to: Reinforced insulation, Insulation material group 1, Pollution degree 2 and overvoltage category III.

<sup>(5)</sup> The results are valid under following conditions: 55°C mean component ambient temperature by continuous operation (8760h per year); Environment condition: ground mobile, no dust or harmful substances, according to IEC61709; Fit equals one failure per 10<sup>9</sup> component hours

### General description of sensor function:

The Sensor is sensitive to AC and DC current and can be used for fault current detection in EV-charging applications. The Sensor detects DC fault currents according to IEC62955:2018 and AC/DC fault currents according to UL2231-2 Ed.2. In the event of a 6mAdc fault current, PIN 7 will change its state from a low level (GND) to high impedance state. In the event of a 20mArms fault current, PIN 6 will change state from a low level (GND) to a high impedance state. Pin 7 only fulfills the switch-off characteristic of the IEC62955 standard (monitoring the dc fault current). An additional driver-circuit must be used for driving a load switch or circuit breaker as defined in IEC62955 / UL2231 as applicable.

Datum	Name	Index	Änderung
03.12.2024	SF	81	UL-Logo added to marking CN-24-67

Editor: R&D-PD NPI D	Designer: SF	MC-PM: BZ	Released by: SB
----------------------	--------------	-----------	-----------------

Differential Current Sensor for EV-charging  
acc. to the partly combined standards  
IEC62955-1:2018 and UL2231-2 Ed.2



Date: 03.12.2024

K-No.:30626

Customer: Standard type

Page 2 of 12

**Mechanical outline (mm):**

General tolerances DIN ISO 2768-c

**Connections:**

PIN no. 1-8: 0.46mm x 0.46mm  
PIN no. 9-12: 0.7mm x 0.7mm

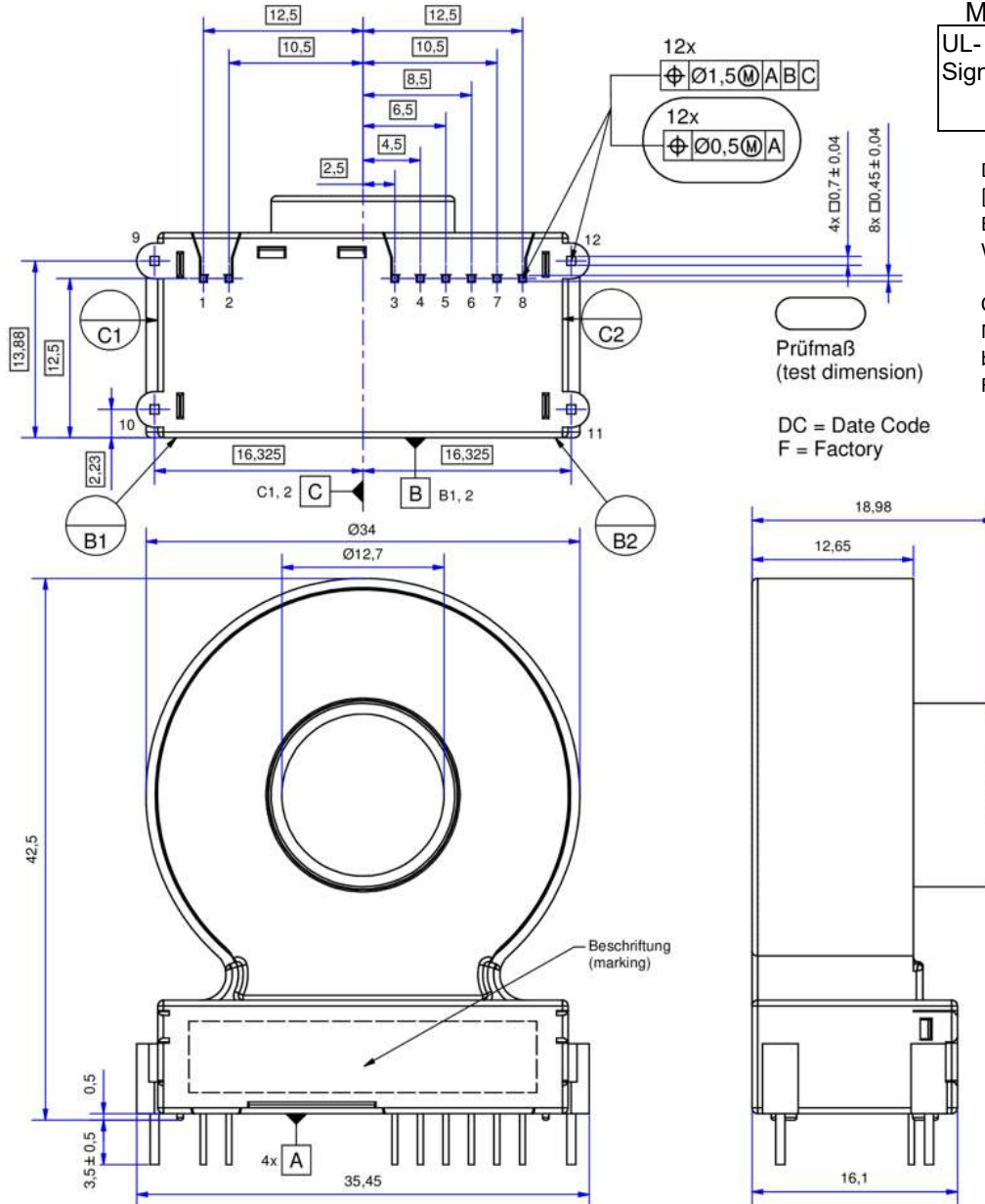
**Marking:**

UL- benvac  
Sign 4641-X836  
F DC



Datecode Format:  
[YWW]  
Example: J04: 2017,  
Week 4

Content of Data-  
Matrix-Code is:  
benvac, 4641-X836,  
F, DC



**Differential Current Sensor for EV-charging  
acc. to the partly combined standards  
IEC62955-1:2018 and UL2231-2 Ed.2**




Date: 03.12.2024

K-No.:30626

Customer: Standard type

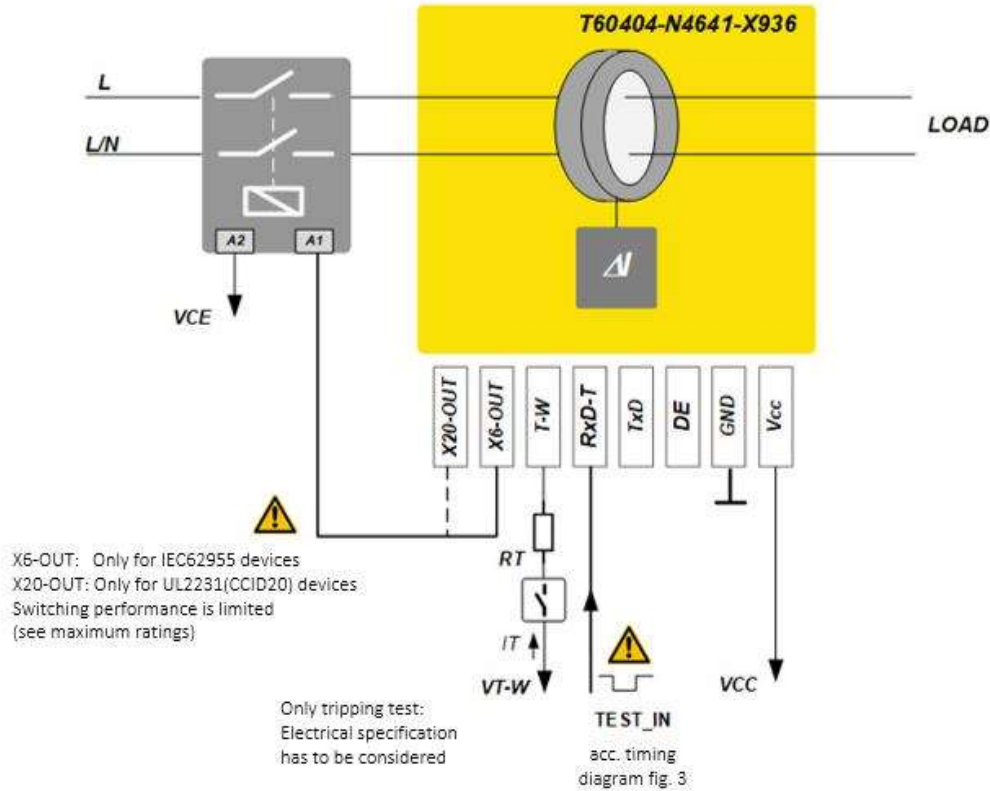
Page 3 of 12

**PIN description:**

PIN no.	Description
PIN 1 → VCC	Positive supply voltage
PIN 2 → GND	Ground connection
PIN 3 → TxD	UART Interface Transmit Data (see Chapter "Serial Data Interface (UART)" for more information)
PIN 4 → RxD-T	<p>UART Interface Receive Data 2<sup>nd</sup> function (Test via internal microcontroller): A function test including an offset measurement is activated if this PIN is connected to GND for a period of 40ms to 1.2s. If the PIN is set to GND less than 40ms or more than 1.2s, no function test will be performed, see timing diagram (fig. 3).</p> <p><b>Attention:</b> During the functional test and offset measurement, no differential current may flow. UART interface is a diagnostic interface and is not suitable for activating protective measures against electric shock (disconnection of the monitored circuit).</p>  <p>To ensure high accuracy of the sensor this test should be activated at regular intervals (e.g. at startup, before measuring...).</p> <p>If a push-pull switch is used, the voltage range must be 0V...5V. (see Chapter "Serial Data Interface (UART)" for more information)</p>
Pin 5 → DE	Drive Enable for Serial communication transceivers. For Typical Application it is left open.
PIN 6 → X20-OUT (open collector output)	X20 switches in acc. to UL2231 (CCID20 requirements) and no system fault occurs the output on PIN 6 is a low level (GND). In any other case PIN 6 is in a high impedance state (see tab. 1).
PIN 7 → X6-OUT (open collector output)	X6 switches in acc. to IEC62955 requirements and no system fault occurs the output on PIN 7 is a low level (GND). In any other case PIN 7 is in a high impedance state. (see tab. 1).
PIN 8 → T-W	Test winding N=25 (max. ratings → 5 mA) Test winding is internally connected to VCC. (see fig. 1)



**Typical application diagram:**

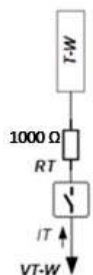


**Fig. 1: Single sensor configuration without using UART**

The sensor can be used without UART Interface. In this case a functional test is carried out by a LOW level signal on terminal RxD-T (acc. timing diagram fig. 3). It is essential to perform a sensor test regularly for proofability of the sensors function correctly.

Figure 3 explains the timing of the functional test via terminal RxD-T. The sensor generates a suitable internal test current to test the tripping levels for the output X6-OUT and X20-OUT (acc. timing diagram fig. 3).

The function of the sensor can also be tested using the test winding. Internally, the test winding is connected to Vcc. With an external switch to pin T-W the test current can be applied, a resistor (RT) in series to the switch and T-W limits the current to the test winding. If the RT resistor is not installed, a short circuit occurs across the test winding, which destroys the sensor. To keep the max ratings of 5 mA a 1k Ohm resistor should be installed. The test current of 125 mA is then obtained through the turns ratio of N = 25.



Current can be calculated by:  $IT = \frac{V_{CC}}{RT} = \frac{5V}{1000\Omega} = 5mA$

**Differential Current Sensor for EV-charging  
acc. to the partly combined standards  
IEC62955-1:2018 and UL2231-2 Ed.2**



Date: 03.12.2024

K-No.:30626

Customer: Standard type

Page 5 of 12

**Absolute maximung ratings<sup>(6)</sup>:**

		Min.	Typ.	Max.	Unit
V <sub>CEO</sub>	Collector-Emitter voltage (PINs 6 and 7)			40	V
I <sub>CC,MAX</sub>	Collector current (PINs 6 and 7)			50	mA
V <sub>CC</sub>	Maximum supply voltage (without function)	-0.3		6	V
U <sub>Max</sub>	Maximum rated insulation voltage			250	V
V <sub>TEST-IN, low</sub>	TEST-IN Input Voltage, low level	0		0.6	V
V <sub>TEST-IN, high</sub>	TEST-IN Input Voltage, high level	2.5		5	V

<sup>(6)</sup>Stresses above these ratings may cause permanent damage.  
Exposure to these conditions for extended periods may degrade device reliability.  
Functional operation of the device at these or any other conditions beyond those specified is not supported. The values described here refer only to the basisinsulation

**Final Tests:** (Measurements after temperature balance of the samples at room temperature, SC=significant characteristic)

		Min.	Max.	Unit
HV	HV-test	1500	0	V
V <sub>cc</sub>	Supply voltage	4.9	5.1	V <sub>Dc</sub>
Status & Calib	Calib. Via UART			
I <sub>cc</sub>	Supply current	16	28	mA
RxD_V <sub>cc</sub>	RxD-T voltage	2.8	3.4	V
X6-OUT (normal)	X6-OUT voltage	0	0.6	V
X20-OUT (normal)	X20-OUT voltage	0	0.6	V
X6-OUT (activated)	X6-OUT voltage activated @5V, 1kΩ (pull-up)	4.9	5.1	V
X20-OUT (activated)	X20-OUT voltage activated @5V, 1kΩ (pull-up)*	4.9	5.1	V
TC1 (SC)	Trip current_1 - X6-OUT +6mA DC / 80A@50Hz	4.5	5.4	mA
TC2	Trip current_2 - X6-OUT -6mA DC	-5.4	-4.5	mA
TC3	Trip current_3 - X20-OUT 20mA@60Hz	14	20	mA
TC4	Trip current_4 - X20-OUT 130mA@1000Hz	105	149	mA
LV1	Limit values of break time - X6-OUT@6mA DC	0	700	ms
LV2	Limit values of break time - X20-OUT@20mA, 60Hz	0	1000	ms
EXT1	Externally winding test - X6 act	4.9	5.1	V
EXT2	Externally winding test - X20 act.	4.9	5.1	V

**Product Tests:** (more EMC test's can be shown if required)

ESD	Acc. to VAC sheet M3238	tbd	
	Air- and contact discharge;	±2.0	kV
	U=±2000V, R=1500Ω, C=100pF		
	Acc. to Human Body Model JESD22-A114		

**Requalification Tests:** (replicated every year, Precondition acc. to M3238)

Û <sub>W, prim-sec</sub>	M3064	Impulse test (1.2µs/50µs waveform) PIN 1-8 vs. primary wire 5 pulse → polarity +, 5 pulse → polarity -	5.5	kV
U <sub>d</sub>	M3014	Test voltage, 60s PIN 1-8 vs. primary wire	1.5	kV rms
U <sub>PDE</sub>	M3024	Partial discharge voltage (extinction) PIN 1-8 vs. primary wire *acc. to table 24 IEC 61800-5-1:2007	1.2	kV rms
U <sub>PD X</sub> 1.875	M3024	Partial discharge voltage (extinction) PIN 1-8 vs. primary wire *acc. to table 24 IEC 61800-5-1:2007	1.5	kV rms

Editor: R&D-PD NPI D

Designer: SF

MC-PM: BZ

Released by: SB

Differential Current Sensor for EV-charging  
acc. to the partly combined standards  
IEC62955-1:2018 and UL2231-2 Ed.2



Date: 03.12.2024

K-No.:30626

Customer: Standard type

Page 6 of 12

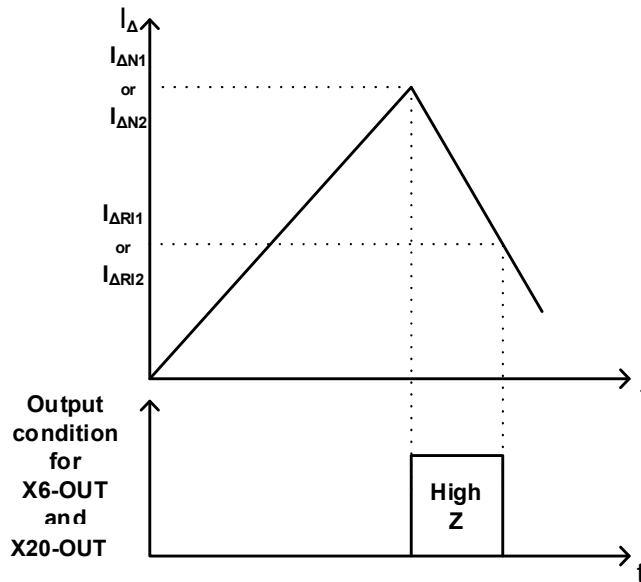
**Other instructions:**

- Temperature of the primary conductor should not exceed 105°C.
- Housing and bobbin material UL-listed, flammability class 94V-0.
- Further standards UL 2231 E-file No. 488116, category FFUQ2 / FFUQ8
- ⚠ The UART-interface is not suitable to use the alarm message for safety measure

**Requirements to be fulfilled by the customer application**

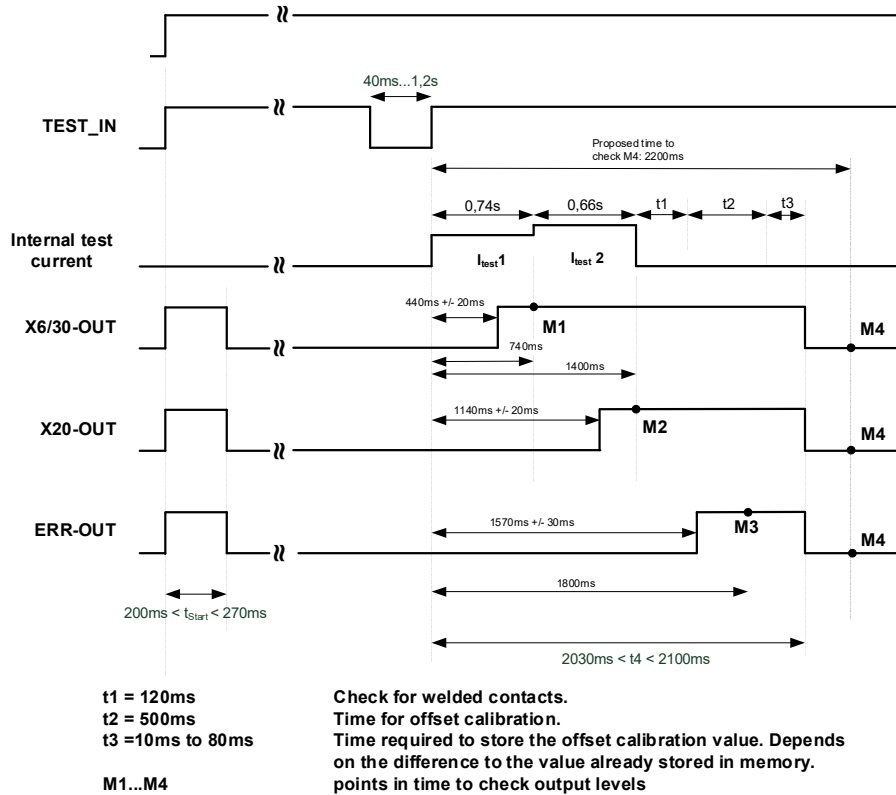
- Vcc during Test-IN function test must be at least 4.8V
- Fall- and rise-time of Vcc:  $t > 20\mu s/V$

**Figures:**

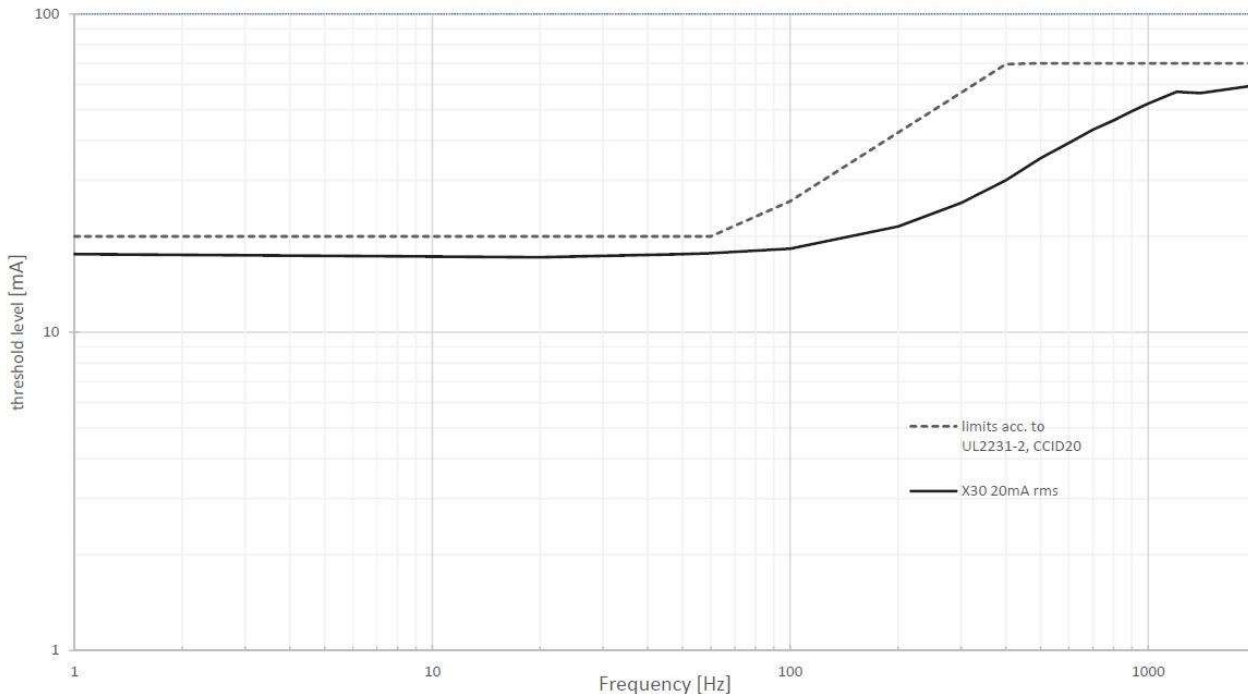


**Fig. 2: Meaning of switching recovery level**

If the trip-level  $I_{\Delta N1}$  is reached the outputs X6-OUT and X20-OUT will change it state from low-level (GND) to high impedance. Depending on the presence of the differential current  $I_{\Delta}$ , the outputs X6-OUT and X20-OUT will remain in this state until  $I_{\Delta}$  falls below recovery threshold  $I_{\Delta R1}$ .



**Fig. 3: Power-Up timing diagram**



**Fig. 5:UL2231 response value over frequency**

Differential Current Sensor for EV-charging  
acc. to the partly combined standards  
IEC62955-1:2018 and UL2231-2 Ed.2



Date: 03.12.2024

K-No.:30626

Customer: Standard type

Page 8 of 12

X6-OUT	X20-OUT	State
GND	GND	Normal condition
High impedance	GND	$I_{\Delta N1} \geq DC6mA$
GND	High impedance	$I_{\Delta N2} \geq AC20mA$
High impedance	High impedance	$I_{\Delta N2} \geq DC20mA$ or Error, system fault

All other conditions not mentioned in the table are not possible. If these conditions occur, the sensor is an unknown state and describes an Error.

**Tab. 1: Possible output states**

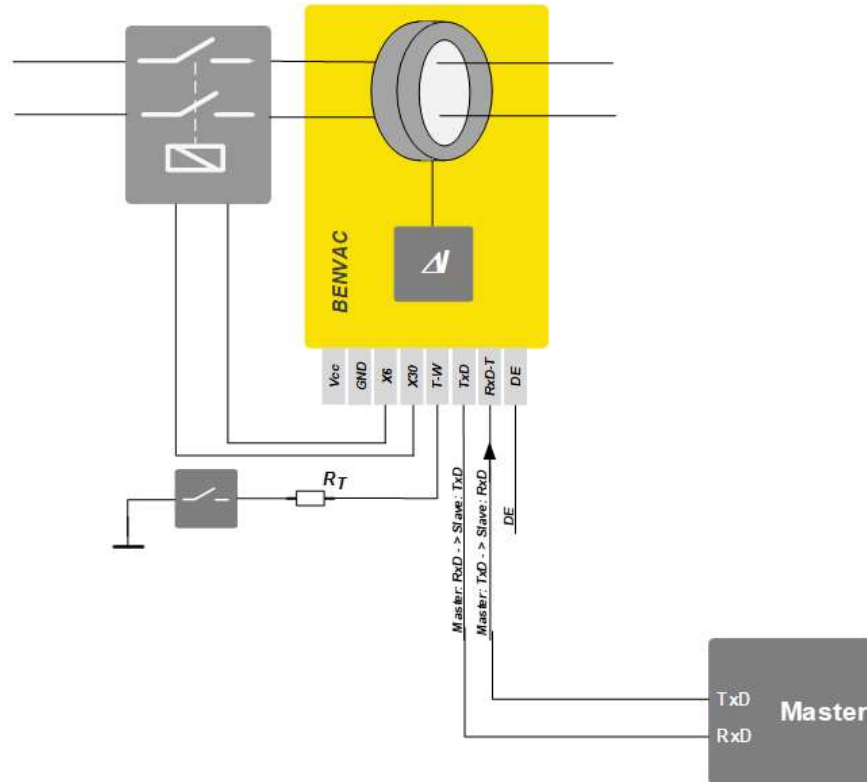
	6mA	60mA	200mA
Standard values acc. to IEC62955:2018	10s	0.3s	0.1s
Typical values of sensor	0.45s	0.06s	0.035s

**Tab. 2: Maximum and typical values of break time for residual direct currents**





**Typical application diagram using UART-interface:**



**Fig 6: UART Typical Application with Master**

Figure 6 explains the typical application for the sensor with additional Master to interface the sensor. In this system, the interface-signals TxD and RxD are cross connected (Master TxD -> Sensor RxD; Master RxD -> Sensor TxD). The master addresses a sensor by sending a message acc. to the protocol described in chapter "Serial Data Interface (UART)".

The sensor monitors and trips via the switching outputs X6-OUT/X20-OUT if the leakage current exceeds the response value.

A functional test can be started by the master using the "start functional test"-message (see chapter "Serial Data Interface (UART)").

The master has access to measured values via the interface by using the "get measurement and status"-message according to chapter "Serial Data Interface (UART)".

**Differential Current Sensor for EV-charging  
acc. to the partly combined standards  
IEC62955-1:2018 and UL2231-2 Ed.2**



Date: 03.12.2024

K-No.:30626

Customer: Standard type

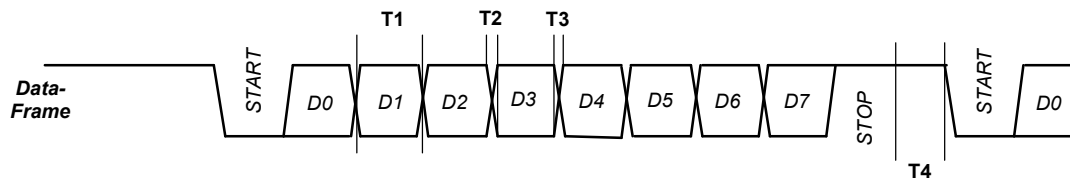
Page 10 of 12

## Serial Data Interface (UART)

Parameter	Specification	Description
Address range	1...255 (0x01 – 0xFF)	Factory setting: 0x64 = 100d
Configuration	10 bit	1 startbit 8 data bits 1 stop bit No parity LSB first
Message format	Address Message code Message length Message data Checksum: 2 Byte	Adress:0x01..0xFF, default address: 0X64 Specification: acc. section "General message format"
Data Direction (DE-PIN)	LOW: Receive data HIGH: transmit data	
TxD voltage signal's	High-signal: 2,7V...3,5V Low-signal: 0,0...0,5V	
RxD voltage signal's	High-signal: 2,4...3,6V Low-signal: 0...0,40V	
Transmission distance	≤200mm	from the sensor pins to a master or interface driver
TxD Output-Resistance	100Ω	
TxD Short circuit behavior	protected	
Data transmitting rate	19200 baud	
Cycle time T1	1/ 19200 (s)	
Falling/rising time T2/T3	< 200ns	

**Tab. 3: Serial Data Interface (UART)**

## Data frame



**Fig. 7: Data format UART-protocol**

## Timing

An idle time of more than 2 bytetimes between 2 bytes is interpreted as end of the message.

The slave starts to send an answer (begin of startbit) by no later than 20ms after reception of the stopbit of the last message byte.

Between 2 requests to a slave, the master shall wait a minimum time of 50ms until the next request. This is to avoid influence on the residual current measurement because of high traffic loads generated by a master.

## Error handling

Each message transmitted has a 16-Bit checksum in the last two bytes transmitted to check the message integrity. The crc is calculated byte by byte incorporating the complete message and then the two crc bytes are appended on the end of the message.

The crc-polynom used is  $0x18005 (x^{16} + x^{15} + x^2 + 1)$ .

If a slave detects a crc-error, it does not answer that request. The master shall repeat the message up to 2 times and if the slave still does not answer, the slave shall be considered to be defective.

**Differential Current Sensor for EV-charging  
acc. to the partly combined standards  
IEC62955-1:2018 and UL2231-2 Ed.2**



Date: 03.12.2024

K-No.:30626

Customer: Standard type

Page 11 of 12

## General message format

Sensor-address	Message-Code	Message-Length	Message-Data[ ]	CRC high byte	CRC low byte
----------------	--------------	----------------	-----------------	---------------	--------------

**Tab. 4: General message format**

The sensor address (1 byte) is the slave address in the range of 1..255. Address 0 is the broadcast address.

The message-code (1 byte) contains the coding instruction of the following bytes.

The message-length (1 byte) contains the length of the optionally following message-data field. 0 means no message-data field follows.

The message-data-field contains the data for the message.

The crc (2 bytes) is calculated from sensor-address up to the last byte of the message-data field.

Numbers larger than 1 byte are transmitted most significant byte first.

Integer numbers are represented in two's complement.

## Messages Overview

Message	Message-Code	Description
Get measurement and status	0x01	Retrieve dc and rms value of the differential current. Get info about operational state, fault state and hardware coded configuration state
Start functional test	0x04	Start a functional test to determine correct switching ability of the sensor hardware

**Tab. 5: Message-Code**

## Start functional test

Master request		Slave answer	
Adr.	address 1..255	Adr.	Slave address
MsgCode	0x04	MsgCode	0x04
MsgLength	0x00	MsgLength	0x01
CRC	crc highbyte	MsgData[0]	Infobyte
CRC	crc lowbyte	CRC	crc highbyte
		CRC	crc lowbyte

**Tab. 6: functional test**

A functional test is started with this command.

Infobyte: 0x00 General problem, request cannot be executed.  
 0x01: Request accepted and will be executed  
 0x02: Request cannot be executed because a test or reset is just active.  
 0x03..0xff: reserved

During the functional test an offset measurement is conducted. Offset measurement takes place during the last max. 600ms before the end of the functional test sequence.

**Differential Current Sensor for EV-charging  
acc. to the partly combined standards  
IEC62955-1:2018 and UL2231-2 Ed.2**



Date: 03.12.2024

K-No.:30626

Customer: Standard type

Page 12 of 12

### Get measurement and status

Master request		Slave answer	
Adr.	address 1..255	Adr.	Slave address
MsgCode	0x01	MsgCode	0x01
MsgLength	0x00	MsgLength	0x07
CRC	crc highbyte	MsgData[0..1]	d <sub>RMS</sub> , Highbyte in MsgData[0]
CRC	crc lowbyte	MsgData[2..3]	d <sub>DC</sub> , Highbyte in MsgData[2]
		MsgData[4]	Statusbyte 1 (Operational state)
		MsgData[5]	Statusbyte 2 (Fault state)
		MsgData[6]	Statusbyte 3 (Configuration state)
		CRC	crc highbyte
		CRC	crc lowbyte

**Tab. 7: Master Slave communication**

The measurement values of residual current rms and dc are represented in 0.1 mA resolution.  
MsgData[0...1] contains the rms value of the residual current.  
The range is 0.0 mA ... 100.0 mA

MsgData[2...3] contains the magnitude of the direct component of the residual current.  
The range is 0.0 mA ... 300.0 mA

Bit	meaning	
Bit 7	General fault	1 = fault
Bit 6	reserved	
Bit 5	Testmode	1 = functional test active 0 = normal measurement
Bit 4	reserved	
Bit 3	reserved	
Bit 2	state of X6	1=on, enabled, not tripped 0=off, disabled, tripped
Bit 1	state of X20	1=on, enabled, not tripped 0=off, disabled, tripped
Bit 0	state of internal ERROR	1 = no error, enabled 0 = error, disabled

**Tab. 8: Statusbyte 1**

Bit	meaning	
Bit 7	reserved	
Bit 6	reserved	
Bit 5	Asic fault	1 = fault
Bit 4	Asic gain fault	1 = fault
Bit 3	Asic offset fault	1 = fault
Bit 2	Feedback fault	1 = fault
Bit 1	reserved	
Bit 0	Configuration fault	1 = fault

**Tab. 9: Statusbyte 2**

Bit	meaning	
Bit 7	reserved	
Bit 6	reserved	
Bit 5	reserved	
Bit 4	reserved	
Bit 3	reserved	
Bit 2	reserved	
Bit 1	Unused always 0	
Bit 0	reserved	

**Tab. 10: Statusbyte 3**